

Wonderful Communication, Mobile Life.

**HUAWEI ASCEND M860**

User Guide

# Contents

<b>1 Reading Before Proceeding</b> .....	<b>1</b>
1.1 Safety Precautions .....	1
1.2 Legal Notice .....	2
<b>2 Getting to Know Your Mobile Phone</b> .....	<b>4</b>
2.1 Mobile Phone View .....	4
2.2 Installing Your Mobile Phone .....	5
2.3 Powering On or Off Your Mobile Phone .....	7
2.4 Using the Touchscreen .....	7
2.5 Locking and Unlocking the Screen .....	8
2.6 Home Screen .....	9
2.7 Using a microSD Card .....	13
<b>3 Calling</b> .....	<b>14</b>
3.1 Making a Call .....	14
3.2 Answering and Rejecting a Call .....	16
3.3 Other Operations During a Call .....	17
3.4 Using Call log .....	18
3.5 Using the Airplane Mode .....	18
3.6 TTY Operation .....	18
3.7 Setting Hearing Aid Compatibility .....	19
<b>4 Contacts</b> .....	<b>20</b>
4.1 Opening the Contacts Application .....	20
4.2 Adding a Contact .....	20
4.3 Searching for a Contact .....	20
4.4 Editing a Contact .....	21
4.5 Communicating with Your Contacts .....	22
4.6 Deleting a Contact .....	22
4.7 Managing Groups .....	22
<b>5 Using the Onscreen Keyboard</b> .....	<b>24</b>
5.1 Displaying the Keyboard Panel .....	24
5.2 Customizing Keyboard Settings .....	25
<b>6 Messaging</b> .....	<b>26</b>
6.1 SMS and MMS .....	26
6.2 Email .....	27
<b>7 Getting Connected</b> .....	<b>30</b>

7.1	Turning on the Data Service .....	30
7.2	Wi-Fi .....	30
7.3	MetroWEB .....	30
7.4	Bluetooth .....	32
<b>8</b>	<b>Entertainment.....</b>	<b>34</b>
8.1	Taking Photos and Recording Videos .....	34
8.2	Using the Gallery .....	36
8.3	Enjoying Music .....	37
<b>9</b>	<b>Google Services.....</b>	<b>39</b>
9.1	Creating a Google Account .....	39
9.2	Using Gmail .....	39
9.3	Using Talk .....	41
9.4	Using Maps .....	42
9.5	Using Market .....	43
<b>10</b>	<b>Synchronizing Information.....</b>	<b>45</b>
10.1	Managing Your Accounts .....	45
10.2	Customizing Your Account Synchronization .....	46
<b>11</b>	<b>Using Other Applications.....</b>	<b>47</b>
11.1	Using the Calendar.....	47
11.2	Using the Alarm.....	48
11.3	Using Sound Recorder .....	49
11.4	Using the File Manager .....	49
11.5	Using the Calculator.....	50
11.6	Using the Notepad.....	50
<b>12</b>	<b>Managing Your Mobile Phone.....</b>	<b>51</b>
12.1	Setting the Date and Time.....	51
12.2	Setting the Display .....	51
12.3	Setting Ringers.....	51
12.4	Setting Phone Services .....	52
12.5	Protecting Your Mobile Phone.....	53
12.6	Managing Applications .....	53
12.7	Resetting Your Mobile Phone.....	54
12.8	Manually Upgrading the Software Version .....	54
12.9	Upgrading the Software Version Through FOTA .....	55
<b>13</b>	<b>Appendix .....</b>	<b>58</b>
13.1	Warnings and Precautions .....	58

# 1 Reading Before Proceeding

## 1.1 Safety Precautions

Please read the safety precautions carefully to ensure the correct use of your mobile phone.



Do not crash, throw, or puncture your mobile phone. Avoid the falling, squeezing, and bending of your mobile phone.



Do not use your mobile phone in a moist environment, such as the bathroom. Prevent your mobile phone from being soaked or washed in liquid.



Do not switch on your mobile phone when it is prohibited to use phones or when the phone may cause interference or danger.



Do not use your mobile phone while driving.



Follow any rules or regulations in hospitals and health care facilities. Switch off your mobile phone near medical apparatus.



Switch off your mobile phone in aircraft. The phone may cause interference to control equipment of the aircraft.



Switch off your mobile phone near high-precision electronic devices. The phone may affect the performance of these devices.



Do not attempt to disassemble your mobile phone or its accessories. Only qualified personnel are allowed to service or repair the phone.



Do not place your mobile phone or its accessories in containers with a strong electromagnetic field.



Do not place magnetic storage media near your mobile phone. Radiation from the phone may erase the information stored on them.



Do not put your mobile phone in a high-temperature place or use it in a place with flammable gas such as a gas station.



Keep your mobile phone and its accessories away from children. Do not allow children to use your mobile phone without guidance.



Use only approved batteries and chargers to avoid the risk of explosions.



Observe any laws or regulations on the use of wireless devices. Respect others' privacy and legal rights when using your wireless device.



Strictly follow the relevant instructions of this manual while using the USB cable. Otherwise your mobile phone or PC may be damaged.

## 1.2 Legal Notice

### **Copyright © Huawei Technologies Co., Ltd. 2010. All rights reserved.**

No part of this document may be reproduced or transmitted in any form or by any means without prior written consent of Huawei Technologies Co., Ltd.

The product described in this manual may include copyrighted software of Huawei Technologies Co., Ltd. and possible licensors. Customers shall not in any manner reproduce, distribute, modify, decompile, disassemble, decrypt, extract, reverse engineer, lease, assign, or sublicense the said software, unless such restrictions are prohibited by applicable laws or such actions are approved by respective copyright holders under licenses.

### **Trademarks and Permissions**



 and **HUAWEI** are trademarks or registered trademarks of Huawei Technologies Co., Ltd.

Other trademarks and product, service and company names mentioned are the property of their respective owners.

### **Notice**

Some features of the product and its accessories described herein rely on the software installed, capacities and settings of local network, and may not be activated or may be limited by local network operators or network service providers. Thus the descriptions herein may not exactly match the product or its accessories you purchase.

Huawei Technologies Co., Ltd. reserves the right to change or modify any information or specifications contained in this manual without prior notice or obligation.

Huawei Technologies Co., Ltd. is not responsible for the legitimacy and quality of any products that you upload or download through this mobile phone, including but not limited to the text, pictures, music, movies, and non-built-in software with copyright protection. Any consequences arising from the installation or usage of the preceding products on this mobile phone shall be borne by yourself.

### **NO WARRANTY**

THE CONTENTS OF THIS MANUAL ARE PROVIDED "AS IS". EXCEPT AS REQUIRED BY APPLICABLE LAWS, NO WARRANTIES OF ANY KIND, EITHER EXPRESS OR IMPLIED, INCLUDING BUT NOT LIMITED TO, THE IMPLIED WARRANTIES OF MERCHANTABILITY

AND FITNESS FOR A PARTICULAR PURPOSE, ARE MADE IN RELATION TO THE ACCURACY, RELIABILITY OR CONTENTS OF THIS MANUAL.

TO THE MAXIMUM EXTENT PERMITTED BY APPLICABLE LAW, IN NO CASE SHALL HUAWEI TECHNOLOGIES CO., LTD. BE LIABLE FOR ANY SPECIAL, INCIDENTAL, INDIRECT, OR CONSEQUENTIAL DAMAGES, OR LOST PROFITS, BUSINESS, REVENUE, DATA, GOODWILL OR ANTICIPATED SAVINGS.

### **Import and Export Regulations**

Customers shall comply with all applicable export or import laws and regulations and will obtain all necessary governmental permits and licenses in order to export, re-export or import the product mentioned in this manual including the software and technical data therein.

## 2 Getting to Know Your Mobile Phone

### 2.1 Mobile Phone View

#### 2.1.1 Phone at a Glance

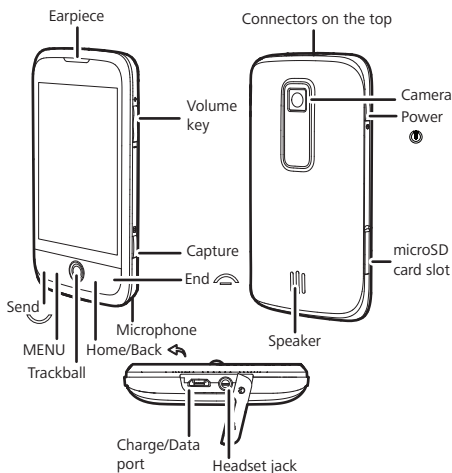

■ **Note:** All the pictures in this guide are for your reference only. The actual appearance and display depend on the mobile phone you purchase.



#### 2.1.2 Key Functions at Your Fingertips

- 
- Press to power on your mobile phone.
  - Press and hold to open the **Phone options** menu.
  - Press to lock the screen when your mobile phone is active.
- 
- Press to go to the **Call log** tab.



MENU	<ul style="list-style-type: none"> <li>• Press to open the menu on an active screen.</li> <li>• Press and hold to open the keyboard so you can perform quick searches.</li> <li>• Press to unlock the screen.</li> </ul>
Trackball	<ul style="list-style-type: none"> <li>• Roll to navigate selectable items on the screen.</li> <li>• Press to select a highlighted item or action.</li> <li>• Press to zoom in or out the Home screen.</li> </ul>
	<ul style="list-style-type: none"> <li>• Press to return to the previous screen.</li> <li>• Press to exit any application you are running.</li> </ul>
	<ul style="list-style-type: none"> <li>• Press to hang up a call.</li> <li>• Press to return to the Home screen.</li> </ul>

■ **Note:**

To customize the function of , touch **Settings > General info & options > End button behavior**.

## 2.2 Installing Your Mobile Phone

### 2.2.1 Installing the Battery

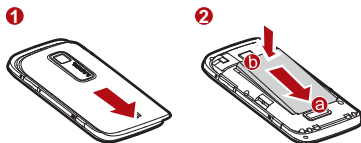

■ **Note:**

Make sure the printed side of the battery points upwards.

1. Remove the battery cover.
2. Angle the edge labelled **a** (with the contacts) into the bottom end of the battery slot.
3. Push down the edge labelled **b** until the battery clicks firmly into place.

### 2.2.2 Charging the Battery

Before charging the battery, ensure that the battery has been properly inserted into your phone.



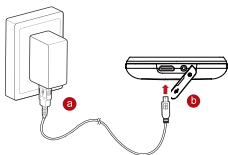

1. Connect the USB cable to the charger, as shown in **a**.
2. Plug the charger into a power socket.
3. Connect the other end of the cable to your mobile phone, as shown in **b**. The phone begins charging.
  - If your mobile phone is charged when it is powered off, a charging icon is displayed on the screen. When the charging icon becomes static, it indicates that your mobile phone is fully charged.
  - If your mobile phone is charged when it is powered on, the battery icon on the Notification bar shows the charging status. When the battery icon changes to , it indicates that your mobile phone is fully charged.

### 2.2.3 Important Information About the Battery

- If the battery has not been used for a long time, your mobile phone might not power on instantly when it is being charged. Allow the battery to charge for a while, and you should be able to power the phone on.
- The battery will not hold a charge for the way it did when it was new. When the battery life becomes noticeably shorter than usual after being charged properly, replace it with a new battery of the same type.
- Using data services will reduce the standby time significantly.
- The time required to charge the battery depends on the ambient temperature and the battery life.
- When the battery is low on power, the phone plays an alert and displays a prompt. When the battery is extremely low on power, the phone will power off automatically.

### 2.2.4 Battery Saving Tips

The longevity of battery power depends on the network that you connect to, and how you use your mobile phone.

Try the following to conserve battery power:

- When your mobile phone is not in use, switch off the screen.
- Reset the time it takes for your screen light to switch off when you leave your phone idle.
- Lower the screen brightness.
- Use the AC adapter to plug your phone into an external power source whenever possible.

- Turn Bluetooth off when you are not using it. Only make your phone visible to other Bluetooth devices when you need to establish a Bluetooth connection.
- Switch off Wi-Fi when you are not using it.
- Turn off your phone connection to GPS satellites when you are not using it.
- Lower the volume.
- Close power-draining programs, when you do not need them.
- Turn off the data service.

## 2.3 Powering On or Off Your Mobile Phone

### 2.3.1 Powering On Your Mobile Phone

Press . The first time you do this, you will be asked to sign in to your account and set up your mobile phone.

### 2.3.2 Setting Up Your Mobile Phone

The first time you power on your mobile phone, the phone displays a setup wizard to instruct you on how to set up the phone.

The setup wizard includes the following parts:

- Using the onscreen keyboard
- Setting up your accounts
- Important settings

### 2.3.3 Powering Off Your Mobile Phone

1. Press and hold the  to open the **Phone options** menu.
2. Touch **Power off**.
3. Touch **OK** when prompted to power off the mobile phone.

## 2.4 Using the Touchscreen

### 2.4.1 Touchscreen Actions

- **Touch:** Touch a desired item with your finger to confirm your selection or start an application.
- **Touch and hold:** Touch and hold the screen until your mobile phone responds. For example, you can always touch and hold the screen to open the options menu of the active screen.
- **Flick:** Flick your finger vertically or horizontally across the screen.
- **Drag:** Touch and hold your desired item with your finger. Then, drag the item to any part of the screen to move the item.

### 2.4.2 Rotating Your Mobile Phone Screen

On most screens, the orientation of the screen rotates with the phone as you turn it from upright to sideways and back again.

## 2.5 Locking and Unlocking the Screen

### 2.5.1 Locking the Screen

- When your mobile phone is on, press the  to lock the screen. When the screen is locked, you can still receive messages and calls.
- If you leave your mobile phone idle for a while, the screen will lock automatically.

### 2.5.2 Unlocking the Screen

Press MENU, , or  to wake up the screen. Then unlock it by doing any of the following:

- Press the MENU key to unlock the screen.
- Drag the lock icon from left to right to unlock the screen.

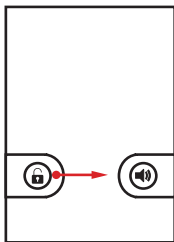

■ **Note:**

If you have set up a screen unlock pattern, you will be prompted to draw the pattern on the screen to unlock it.

## 2.6 Home Screen

### 2.6.1 Home Screen View

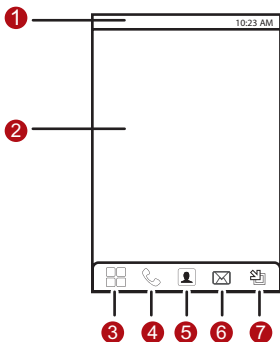

---

1 **Notification bar:** Displays the notifications and status icons of your mobile phone. Flick down to open the notification panel.

---

2 **Display area:** Shows the operation and display areas of your mobile phone.

---

3 Touch to open the **Main Menu**.

---

4 Touch to open the **Dialer**.

---

5 Touch to open the **Contacts**.

---

6 Touch to open the **Messaging**.



























---

7 **Zoom button:** Touch to view thumbnails of the Home screen, which you can touch to open.

---

## 2.6.2 Notifications and Status Information

### Notification and Status Icons

 Call in progress	 Call in progress using a Bluetooth device
 Missed call	 Connected to a PC
 Error	 Memory is full
 Preparing microSD card	 Music is playing
 Downloading data	 Uploading data
 Roaming	 Signal strength
 No signal	 Airplane mode
 Synchronizing data	 Synchronization failed
 Bluetooth is on	 Connected to another Bluetooth device
 GPS connected	 Connected to a Wi-Fi network
 Sound off	 Speaker on
 Vibrate mode	 Microphone off
 Battery is full	 Battery is very low
 Battery is charging	 Alarm is set
 New calendar reminder	 New instant message
 New email	 New message
 New voicemail	 More undisplayed notifications



DM or FOTA download  
session ongoing

## Notification Panel

Open the notification panel to see who the wireless network operator is, or view a message, reminder, or event notification.

### Opening the Notification Panel

1. When a new notification icon appears on the notification bar, touch and hold the notification bar, and then flick down to open the notification panel.
2. On the notification panel, you can do the following:
  - Touch a notification to open the related application.
  - Touch **Clear** to clear all notifications.

### Closing the Notification Panel

Touch and hold the bottom of the panel. Then flick up to close it.

## 2.6.3 Customizing the Screen

### Adding an Item to the Home Screen

1. Touch and hold the blank area on the Home screen until the **Add to Home screen** menu is displayed.
2. Select an item to add it to the Home screen.

### Moving a Screen Item

1. Touch and hold an icon on the Home screen until the icon magnifies and the mobile phone vibrates.
2. Without lifting your finger, drag the icon to the desired position on the screen, and then release it.

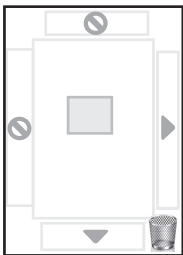



The desktop cannot be expanded at this time.



Drag an item to the direction.

### Removing a Screen Item

1. Touch and hold an icon on the Home screen until the icon magnifies and the mobile phone vibrates.
2. Without lifting your finger off the item, drag it to the trash can . The item and the trash can will turn red , indicating that the item is ready to be removed.
3. Release the item to remove it from the Home screen.

### 2.6.4 Adding a Widget

A widget works as a shortcut to let you preview or use an application. You can stick widgets on your desktop as icons or preview windows. Besides the default widgets installed on your phone, you can also download more from Android Market.

To add a widget to the Home screen:

1. Touch and hold the blank area on the Home screen.
2. In the displayed menu, select **Android widgets** or **Huawei widgets** in which contains the widget you want to use.
3. Touch your desired widget.

### 2.6.5 Changing the Wallpaper

1. On the Home screen, press the **MENU** button, and then touch **Wallpaper**.
2. Touch option to select a picture and set it as the wallpaper.

### 2.6.6 Changing a Theme

1. On the Home screen, press the **MENU** button, and then touch **Themes**.
2. Touch the theme you want to use. Your theme will be changed automatically.

## 2.7 Using a microSD Card

### 2.7.1 Installing the microSD Card

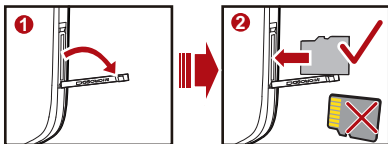

1. Open the microSD card cover.
2. Insert the microSD card into the card slot as shown in the diagram.

■ **Note:**

When inserting the microSD card, make sure that the golden contact faces downwards.

### 2.7.2 Using the microSD Card as USB Mass Storage

To transfer all your favorite music and pictures from your PC to your mobile phone's microSD card, set the microSD card as USB mass storage.

1. Connect your mobile phone to your PC with the USB cable. Your PC will detect the microSD card as a removable disk. You can now transfer files from your PC to your mobile phone's microSD card.
2. Open the notification bar, and then touch **USB connected**.
3. Touch **Mount** in the dialog box that opens to confirm that you want to transfer files.

★ **Tip:**

You can also touch  > **Settings** > **General info & options**, and then select the **USB Mass Storage** check box to use the microSD card as the USB mass storage.

■ **Note:**

When your microSD card acts as USB mass storage, your mobile phone will not use this memory space. Your PC will tell you how to safely disconnect the USB mass storage device (your mobile phone) when you have finished transferring files.

### 2.7.3 Removing the microSD

1. Touch  > **Settings**.
2. Scroll down the screen, and then touch **SD card & phone storage** > **Unmount SD card**.
3. Remove the microSD card carefully.



## 3 Calling

To place a phone call, you can dial a number or touch a number in your contacts list, on a Web page, or from a document that contains a phone number. When you are on a call, you can either answer incoming calls or send them to your voicemail box. You can also set up conference calls with several participants.

### 3.1 Making a Call

To make a call, you can use the **Dialer** application, or select a number from **Contacts** or **Call log**.

When you are on a call, you can press  to return to the Home screen and use other functions. To return to the calling screen, flick the notification bar down and touch **Current call**.

■ **Note:**

Do not block the microphone at the bottom of your phone if you want your voice heard.

#### 3.1.1 Making a Call with the Dialer

1. Touch  > **Dialer** to display the dialer.

If you are already working with **Contacts** or **Call log**, touch the **Dialer** tab.

2. Touch the appropriate numeric keys to enter the phone number.

★ **Tip:** Your mobile phone supports the SmartDial function, that is, when you touch numbers on the dialer, the phone automatically searches among your contacts and lists the matching results based on the accuracy. If no contact is matched with your entered information, the phone will not display any result.

3. Press  or touch  to initiate the call.

During a call, flick up the **Dialpad** tab to enter other numbers on the dialpad.

## Dialing Panel

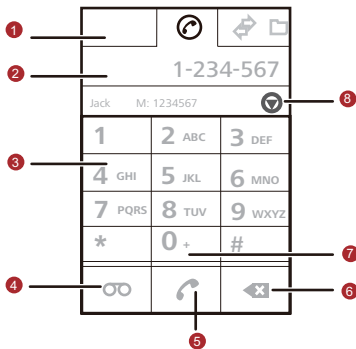

- 
- 1 Touch to switch between **Dialer**, **Call log**, **Contacts**, **Favorites** and **Groups**.

---

  - 2 Displays the number you enter.

---

  - 3 Touch to enter the number.

---

  - 4 Touch to make a voicemail.

---

  - 5 Touch to dial a number.

---

  - 6 Touch to erase each subsequent digit of a number. Touch and hold to erase the entire number.



---

  - 7 Touch and hold to enter +.



---

  - 8 Touch to display all the matching contacts.
- 

### 3.1.2 Making a Call from Contacts

1. Touch  > **Contacts** to display the contact list.  
If you are already working with **Dialer** or **Call log**, touch the **Contacts** tab.
2. In the list, touch the contact you want to call.
3. Touch  to dial the phone number.

### 3.1.3 Making a Call from Call log



1. Touch  > **Call log** to display the call log.  
If you are already working with **Contacts** or **Dialer**, touch the **Call log** tab.
2. Touch  to the right of the log entry to dial.  
★ **Tip:** If you touch and hold the log entry, the options menu will open.

## 3.2 Answering and Rejecting a Call

### 3.2.1 Answering an Incoming Call

When you receive a phone call, the incoming call screen opens with the caller ID and any additional information about the caller that you have entered in **Contacts**.

■ **Note:** If the caller phone number is not stored in your **Contacts**, the incoming call screen displays the caller ID that is assigned to the caller from the network if any.

- Press  to answer the call.
- Drag the  to the right.

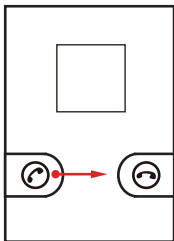

### 3.2.2 Ending a Call

During a call, press  to hang up.

### 3.2.3 Rejecting an Incoming Call

- Press  to reject a call.
- Drag the  to the left.

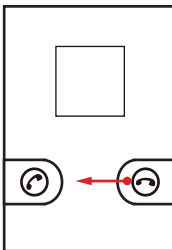



## 3.3 Other Operations During a Call

### 3.3.1 Making a Conference Call

You can set up a conference call with multiple callers.

■ **Note:**

Contact your network operator to learn whether it supports conference calls and how many participants you can add.

1. To initiate a conference call, dial the number of the first person to be on the call. While you are on that call, press **MENU**, and then touch **Add call**.
2. Enter the phone number of the person you want to join the conversation and press , or select someone from your **Call log** or **Contacts**. The first call is automatically placed on hold.
3. Once you have connected to the person you have added, press **MENU**, and then touch **Merge calls** to begin the conference call.
4. To add more people, touch **Add call** and repeat steps 2 and 3.
5. To end the conference call and disconnect everyone, press .

### 3.3.2 Switching Between Calls

If you receive a new call while you are already on a call, you can switch between the two calls.

1. While you are on two calls, press **MENU**, and then touch **Swap calls**.
2. The current call is placed on hold and you are connected to the other call.

### 3.3.3 Using the headset

Using the center button of the headset, you can answer, reject, end, or mute calls.

- To answer an incoming call, press the center button.
- To reject an incoming call or end an ongoing call, press and hold the center button.
- To mute an ongoing call, press the center button. Press the center button again to unmute.

## 3.4 Using Call log

The **Call log** contains a list of calls that you have dialed, received, or missed. You can use the call log to quickly find a recently called number or add an incoming number to your contact list.

### 3.4.1 Adding an entry to Contacts

1. Touch  > **Call log** to display the call log.
2. Touch and hold the entry you want to add.
3. Touch **Add to contacts** in the options menu.
4. Touch **Create new contact** or scroll through the contact list and touch an existing contact name.

## 3.5 Using the Airplane Mode

Some locations may require you to turn off your phone's wireless connections. Rather than powering off your phone, you can place it in **Airplane mode**.

1. Press and hold .
2. Touch **Airplane mode** in the options menu.

## 3.6 TTY Operation

### 3.6.1 Using the TTY Device

The Teletypewriter (TTY) is a typewriting device. By connecting the phone to the TTY device, you can use the TTY functions to send/receive messages. When you use the TTY function, do as follows:

1. Connect the TTY device to the headset jack of the phone and set the phone to the TTY mode.
2. Make or answer calls as normal.
3. When the call is put through, use the TTY device to send or receive the letters.
4. Press the  to end the call.

### 3.6.2 Setting the TTY Mode

1. touch  > **Settings** > **Call settings** > **TTY mode**.
2. Select one TTY mode.
  - **TTY Off**: The standard voice speaking mode and the listening mode.
  - **TTY Full**: Transmit and receive the TTY characters.
  - **TTY HCO**: Transmit TTY characters but receive by listening to the earpiece.
  - **TTY VCO**: Receive TTY characters but transmit by speaking into the microphone.

### 3.7 Setting Hearing Aid Compatibility

Touch  > **Settings** > **Call settings** > **Hearing aids** to set your phone to be compatible with a hearing aid.

## 4 Contacts

The Contacts application enables you to save and manage information such as phone numbers and addresses of your contacts. After you save the contact information on your mobile phone, it gives you an easy access to the people with whom you want to communicate.

### 4.1 Opening the Contacts Application

If you have a new mobile phone and have not yet added any contacts, **Contacts** displays a message with hints on how to start adding contacts to your mobile phone.

- Touch  > **Contacts**.
- Press , and then touch the **Contacts** tab.

All of your contacts are displayed alphabetically in a scrolling list. Each contact is followed by the phone number that you have specified as the person's default phone number.

### 4.2 Adding a Contact

1. In the contacts list, press **MENU**, and then touch **Create contact**.  
**★ Tip:** In the contacts list, you can touch  to add a new contact.
2. If you have more than one account with contacts, touch the account to which you want to add the contact.
3. Enter the contact's name, and then add any detailed information such as phone number or address.
4. When you are finished, touch **Done** to save the contact information.

#### 4.2.1 Adding a Contact to Your Favorites

To add a contact to your favorites, you can do any of the following while you are in the contacts list:

- Touch and hold the contact you want to add to **Favorites**. Then touch **Add to Favorites**.
- Access the favorites list, press **MENU**, and then touch **Add favorites** to select the contacts you want to add to **Favorites**.
- Touch a contact, and then touch the star to the right of the contact's name. The star turns gold.

### 4.3 Searching for a Contact

1. In the contacts list, press **MENU**, and then touch **Search**.  
**★ Tip:** In the contacts list, you can also touch  to search for a contact.
2. Enter the name of the contact for which you are searching. As you type, contacts with matching names appear below the search box.

## 4.4 Editing a Contact

You can always make changes to the information you have stored for a contact.

1. In the contacts list, touch and hold the contact whose details you want to edit, and then touch **Edit contact** in the options menu.

You can also press **MENU**, and then touch **Edit contact** while viewing a contact's details.

2. Touch a category of contact information, such as contact's name, phone number or email address, to enter that kind of information about your contact.
3. Make the desired changes to the contact information, and then touch **Done**. To cancel all changes you made to the contact information, touch **Cancel**.

### 4.4.1 Contact Editing Screen

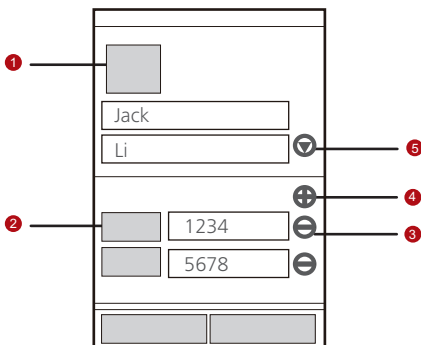

- 
- 1 Touch the Picture Frame icon to select a picture to display next to the name in your list of contacts and in other applications.

- 
- 2 Touch to open a menu with preset labels, such as **Mobile** and **Work** for a phone number, or touch **Custom** in the menu to create your own label.

- 
- 3 Touch to remove the entry from that category.

- 
- 4 Touch to add more than one entry for that category.

- 
- 5 Touch to display more text boxes for entering the name details such as middle name and last name.
-



## 4.5 Communicating with Your Contacts

From the **Contacts** tab, you can quickly call or send a text (SMS) or multimedia message (MMS) to a contact's default phone number. You can also open details to view a list of all the ways you can communicate with that contact. This section describes how to communicate with a contact when you view your contacts list.

### 4.5.1 Connecting Through Quick Contact for Android

1. Touch the contact's picture or picture frame (if you have not assigned a picture to the contact) to open Quick Contact for Android.
2. Touch the icon for the way you want to communicate with the contact.  
**■ Note:** The icons available depend on the information you have for the contact and the applications and accounts on your mobile phone.

### 4.5.2 Communicating with a Contact

1. In the contacts list, touch the contact that you want to communicate.
2. In the contact's details screen, touch the green icon to the right of the number to call or send messages.

## 4.6 Deleting a Contact

1. In the contacts list, touch and hold the contact that you want to delete, and then touch **Delete contact** in the options menu.
2. Touch **OK** to confirm that you want to delete the contact.

## 4.7 Managing Groups

### 4.7.1 Creating a Group

1. Press , and then touch the **Groups** tab.
2. In the groups list, press **MENU**, and then touch **Create group**.
3. Enter the name and picture you want to store for the group, and then give the group a ringtone.
4. Touch **Add Members** to add members on the group list.
5. Select the contacts to be added to the group, and then touch **OK**.
6. When you are finished, touch **Done** to save the group information.

### 4.7.2 Editing a Group

You can always make changes to the information you have stored for a group.

1. In the groups list, touch and hold the group whose details you want to edit, and then touch **Edit group** in the options menu.
2. Make the desired changes to the group information, and then touch **Done**. To cancel all changes you made to the group information, touch **Cancel**.

### 4.7.3 Adding a Contact to Your Groups

To add a contact to your groups, you can do any of the following:

- Touch and hold the contact you want to add to **Groups**. Then touch **Add to groups**.
- When editing a group, press **MENU**, and then touch **Add Members** to select the contacts you want to add to group.

## 5 Using the Onscreen Keyboard

### 5.1 Displaying the Keyboard Panel

To enter text, use the onscreen keyboard. Some applications open the keyboard automatically. In others, touch a text field to open the keyboard. To open the keyboard, do one of the following:

- Press and hold **MENU** to display the keyboard.
- Touch the space where you want to write text to display the keyboard.

Press  to hide the keyboard.

#### ★ Tip:

Touch and hold the space where you usually write your text to open the options menu.

#### 5.1.1 Choosing an Input Method

1. On the text screen, touch and hold the space where you usually write your text until the **Edit text** menu is displayed.
2. Touch **Input method**.
3. Select the input method.

The keyboard panel will be displayed automatically.

#### 5.1.2 Using the Android Keyboard



---

1 Touch to change from lowercase to uppercase.

---

2 Touch to change from text mode to symbol/number mode. Touch again to change back.

---

3 Touch to insert a space.

---

4 Touch to insert a smiley in your text.

---

- 
- 5 Touch to delete a character to the left of the cursor. Touch and hold to delete all characters to the left of the cursor.
- 

### 5.1.3 Using the Landscape Keyboard

If you find the keyboard inconvenient or difficult to use, turn your mobile phone sideways. The screen will display the keyboard in landscape orientation, providing you with a wider keyboard layout.

## 5.2 Customizing Keyboard Settings

Touch  > **Settings** > **Language & keyboard** to customize the keyboard settings.

## 6 Messaging

The Messaging application allows you to exchange text messages (SMS) and multimedia messages (MMS) with anyone using an SMS-or-MMS-capable phone. With the **Email** application you can read and send emails.

### 6.1 SMS and MMS

**Text messages:** One text message can contain up to 160 (English) / 70 (Spanish) characters. You can send a text message of any length. If the message length exceeds 160 (English) / 70 (Spanish) characters, the message will be sent as a multimedia message (MMS) and charged in the rate of a multimedia message.

**Multimedia messages:** Multimedia messages make everyday messages extra special. You can record a message and send it as an audio file or send a slideshow of photographs. For example, you can sing "Happy Birthday" to someone, send them a video message, or send photos of a special event.

#### 6.1.1 Opening Messaging

Touch  > **Messaging**.

#### 6.1.2 Creating and Sending a Text Message

1. Touch  > **Messaging** > **New message**.
2. Enter a phone number in the **To** field, or touch + to select a contact from **Contacts**.

As you enter the phone number, matching contacts appear. You can touch a suggested recipient or continue entering the phone number.

3. Touch the composition text box to start entering your message.

★ **Tip:** If you want to enter a smiley face, press **MENU**, and then touch **Insert smiley**.

If you press  while composing a message, it is saved as a draft in your message list. Touch the message to resume composing it.

4. Once you are done, touch **Send**.

The message list opens, and your name appears in the list, followed by the message you just sent. Responses appear in the window. As you view and send additional messages, a message thread is created.

#### 6.1.3 Creating and Sending a Multimedia Message

1. Touch  > **Messaging** > **New message**.
2. Enter a phone number in the **To** field, or touch + to select a contact from **Contacts**.

You can also press **MENU**, and then touch **Add recipient** to add more recipients.

3. Touch the composition text box to start entering your message.

4. Press **MENU** to display the options panel.
  - Touch **Add subject** to add the message subject. Your mobile phone is now in multimedia message mode.
  - Touch **Attach** to add a picture, music, or video file.
5. When the message is ready to be sent, touch **Send**.

### Adding a Slideshow

If you want to attach more than one file to your message, use the Slideshow option.

1. On the message editing screen, press **MENU** to display the options panel.
2. Touch **Attach** > **Slideshow**, and then select a slide to start editing it.
3. Press **MENU**, and then touch **More** > **Add slide** to add more slides.  
You can touch the green arrow icons to switch between slides.
4. Touch **Done** to finish composing your message and return to the multimedia message screen.
5. To alter your multimedia message, touch **Edit** on the multimedia message screen. When the message is ready to be sent, touch **Send**.

### 6.1.4 Opening and Viewing a Multimedia Message

1. In the message list, touch the message thread to open it.
2. Touch the multimedia message to view the message.
3. Flick left or right to view the previous or next slide.

### 6.1.5 Replying to a Message

1. In the message list, touch a text or multimedia message thread to open it.
2. Touch the text box to compose your message, and then touch **Send**.

### 6.1.6 Customizing the Message Settings

In the message list, press **MENU**, and then touch **Settings** to customize the message settings.

## 6.2 Email

Your mobile phone puts email at your fingertips, too. Using your Email application, you can add versions of Yahoo!, AOL, and other popular email services to your phone. These types of email accounts are known as POP3, Exchange or IMAP.

### 6.2.1 Adding an Email Account

When using the **Email** application for the first time, you must configure your email account. The Email setup wizard helps you set up your account for many popular email systems, so you can read and work with the same email that you do on a computer in a web browser, or with another email application.

1. Touch  > **Email**.

- To customize your email settings, answer the onscreen prompts, and then touch **Next**. Or touch **Manual setup** if you want to set the mail server yourself.  
**■ Note:** If you touch **Manual setup**, contact your email service provider for the parameters required for your account if you don't know what they are.
- Enter the name for your account and the name you want other people to see when they receive an email from you.
- Touch **Done**.

Your mobile phone starts your email messages from your email account on the web and you can start using the phone to send and receive messages.

After the initial setup, your email application opens to the last screen you were viewing or, if you have not used **Email** recently, it displays the contents of your Inbox or the accounts screen (when you have more than one account).

### Adding Other Email Accounts

- After creating your initial email account, press **MENU** on the **Inbox** screen, and then touch **Accounts** to access the accounts screen.
- Press **MENU** on the accounts screen, and then touch **Add account** to create another email account.

#### ★ Tip:

When adding a subsequent email account, you can also select the option to use the new account to send all outgoing messages.

### 6.2.2 Viewing an Email Message

- On the accounts screen, touch the email account you want to use.
- Access a folder, and then touch the message that you want to view.

### 6.2.3 Creating and Sending an Email Message

- On the accounts screen, touch the email account you want to use.
- On the **Inbox** screen, press **MENU**, and then touch **Compose** in the options panel.
- In the **To** field, enter the name or the email address.
- Write the subject and email.

To send an attachment with the message, press **MENU**, and then touch **Add attachment**.

- When you are finished, touch **Send**.

If you are not ready, touch **Save as draft** or press  to save the message as a draft.

### 6.2.4 Replying to an Email Message

- On the accounts screen, touch the email account you want to use.
- Touch the email message you want to view and reply to.
- Touch **Reply** or **Reply all** to reply to the email message.

## 6.2.5 Deleting an Email Account

1. On the accounts screen, touch and hold the email account you want to delete.
2. Touch **Remove account**.
3. Touch **OK**.

## 6.2.6 Changing Email Account Settings

You can change a number of settings for an account, including how often you check for emails, how you are notified of a new mail, and details about the servers the account uses to send and receive mails.

■ **Note:**

Your account's incoming and outgoing settings depend on the kind of email service for your account: IMAP or POP3. You can enter the necessary details manually, although you will typically need to contact your email service provider to determine the right settings for the account.

1. Touch  > **Email**.
2. On the accounts screen, touch and hold the email account you want to change.
3. Touch **Account settings**.
4. Change **General settings**, **Notification settings**, or **Server settings**.



## 7 Getting Connected

### 7.1 Turning on the Data Service

1. Touch  > **Settings**.
2. Touch **Wireless & networks** > **Mobile networks**.
3. Select the **Data Service** check box to turn on the data connection.

### 7.2 Wi-Fi

Wi-Fi gives you wireless access to broadband Internet access. To use Wi-Fi on your mobile phone, you need to have an access to wireless access points (hotspots). Obstacles that block the Wi-Fi signal will reduce its strength.

#### 7.2.1 Turning On Wi-Fi

1. Touch  > **Settings**.
2. Touch **Wireless & networks**, and then select the **Wi-Fi** check box to turn on Wi-Fi.

#### 7.2.2 Connecting to a Wireless Network

1. After turning on Wi-Fi, touch  > **Settings**.
2. Touch **Wireless & networks** > **Wi-Fi settings**. You will see a list of detected Wi-Fi networks in the **Wi-Fi networks** section.
3. Touch a Wi-Fi network to connect to it.
  - If you select an open network, you will be automatically connected to the network.
  - If you select a network that is secured with Wired Equivalent Privacy (WEP) and connect to it for the first time, enter the password, and then touch **Connect**. If you connect to a secured wireless network that you have already used, you will not be prompted to enter the password again unless you reset your mobile phone to its default settings.

★ **Tip:**

On the **Wi-Fi settings** screen, touch **Add Wi-Fi network** to add a new Wi-Fi network.

### 7.3 MetroWEB

Your mobile phone comes with a browser. You can use **MetroWEB** to access and browse the Internet.

#### 7.3.1 Opening the MetroWEB

Touch  > **MetroWEB** to home page.

Open the MetroWEB options menu and perform one of the following operations, press **MENU**:

- **New window:** Touch to open a new window.
- **Bookmarks:** Touch to display bookmarks.

- **Windows:** Touch to go to the web preview screen. You can switch to another web page or open a new web page on this screen.
- **Refresh:** Touch to refresh the current page.
- **Forward:** Touch to browse the next web page.
- **More:** Touch to open other menus and perform operations such as searching, selecting text, downloading, or setting options.

### 7.3.2 Opening a Web Page

1. In a MetroWEB window, touch the URL field at the top of the screen.
2. Use the keyboard to enter the web page address.
3. As you enter the address, matching web page addresses will appear on the screen. If you see the address you want, touch it and go directly to that web page or complete entering the address of the web page you want.
4. Touch **Go**.

### 7.3.3 Setting a Home Page

1. In a MetroWEB window, press **MENU**.
2. Touch **More > Settings > Set home page**.
3. Enter the address of the desired home page, and then touch **OK**.

### 7.3.4 Managing Bookmarks

You can store as many bookmarks as you want on your mobile phone.

#### Adding a Bookmark

1. In a MetroWEB screen, go to the web page you want to save as a bookmark.
2. Press **MENU**, and then touch **Bookmarks > Add**. The add bookmark screen opens.
3. Edit the bookmark name as needed and then touch **OK**.

#### Opening a Bookmark

1. In a MetroWEB window, press **MENU**, and then touch **Bookmarks**.  
On the **Bookmarks** screen, touch the **History** tab to view the pages you have visited. Or touch the **Most visited** tab to view the pages you have visited most frequently.
2. Touch the bookmark of the website you want to open.

### 7.3.5 Customizing the MetroWEB Settings

Customize the MetroWEB to suit your browsing style. Use **MetroWEB** to set page content, privacy, and security preferences. In the MetroWEB screen, press **MENU**, and then touch **More > Settings**.

## 7.4 Bluetooth

Your mobile phone has Bluetooth, which allows you to create a wireless connection with other Bluetooth devices so you can share files with your friends, talk hands-free with a Bluetooth headset, or even transfer photos on your phone to your PC.

If you are using Bluetooth, remember to stay within 10 meters (33 feet) of other Bluetooth devices. Be aware that obstacles like walls or other electronic equipment may interfere with your Bluetooth connection.

### 7.4.1 Turning On Bluetooth

1. Touch  > **Settings**.
2. Touch **Wireless & networks**, and then select the **Bluetooth** check box to turn on Bluetooth. When Bluetooth is turned on, the Bluetooth icon appears in the notification bar.
3. Touch **Bluetooth settings**, and then select the **Discoverable** to make your mobile phone visible to other Bluetooth devices.

### 7.4.2 Pairing and Connecting a Bluetooth Device

Your mobile Bluetooth lets you do the following:

- Hands Free Profile (HFP): allows you to use a hands-free Bluetooth device.
- Headset Profile (HSP): allows you to use a mono Bluetooth headset.
- Object Push Profile (OPP): allows you to transfer files through Bluetooth.
- Advanced Audio Distribution Profile (A2DP): allows you to use a stereo Bluetooth headset.
- AV Remote Control Profile (AVRCP): allows you to control what plays through the Bluetooth headset remotely.

Before you use Bluetooth, you need to pair your mobile phone with another Bluetooth device as follows:

1. Ensure that the Bluetooth function on your mobile phone is enabled.
2. Touch  > **Settings** > **Wireless & networks** > **Bluetooth settings**. Your mobile phone will then scan for Bluetooth devices in range (or touch MENU > **Scan for devices** to scan for Bluetooth devices).
3. Touch the device you want to pair with your mobile phone.
4. Enter the pairing password to complete the connection.

### 7.4.3 Sending Files via Bluetooth

With Bluetooth, you can share pictures, videos, or music files with your family and friends. To send files via Bluetooth, do as follows:

1. Touch  > **File Manager** to open the file manager.
2. Touch and hold the file to be sent. The active options menu is displayed.
3. Touch **Share**, and then touch **Bluetooth** to select a paired device.

## 7.4.4 Disconnecting or Unpairing a Bluetooth Device

1. Touch  > **Settings** > **Wireless & networks** > **Bluetooth settings**.
2. Navigate to the **Bluetooth devices** section, and then touch and hold the connected device.  
You can also just touch a connected device to disconnect it.
3. Touch **Disconnect** or **Unpair** to disconnect the device.



## 8 Entertainment

In addition to being a communication device and personal assistant, your mobile phone also provides you with a multitude of entertainment possibilities. You can take photos, create videos and audio clips, and download and listen to music.

### 8.1 Taking Photos and Recording Videos

The camera is a combination of camera and camcorder that you can use to shoot and share pictures and videos.

#### 8.1.1 Opening Your Camera

- Touch  > **Camera** to open the camera. The camera opens in landscape mode, ready to take a picture or shoot a video.
- Press  on the picture capture screen to close the camera.

#### Capture Screen

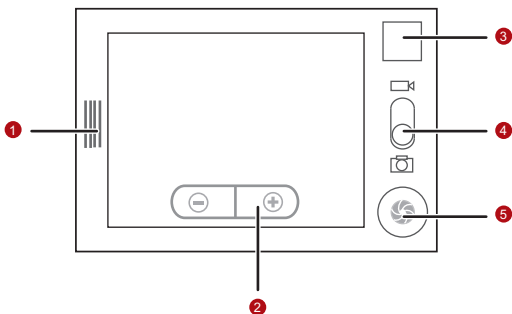

On the capture screen, touch the screen to show the zoom in or out controls.

- 
- 1 Touch to open the settings panel.

---

  - 2 Touch to zoom in or out.

---



  - 3 Thumbnail of last photo. Touch to preview the photos or videos.

---

  - 4 Drag up to shoot videos (camcorder mode), drag down to take photos (camera mode).
-

On the capture screen, press **MENU** key to show the capture panel.

### 8.1.2 Taking a Photo



1. Open your camera and switch to the camera mode.
2. If necessary, open the settings panel to change the camera settings. The preview changes as you change the settings.
3. Compose your photo within the photo capture screen.
4. Touch and hold . When the frame turns green, the image is in focus.
5. Release  to take your photo.

The photo you just took is displayed for a moment. You can take another photo or preview your photos.



### 8.1.3 Viewing Your Photos

1. After taking a photo, a thumbnail of the photo you have just taken is shown in the upper right corner of the Capture screen. Touch the thumbnail to view it.
2. Touch the onscreen button to do any of the following:
  - Touch **DELETE** to delete the photo.
  - Touch **SHARE** to send the photo in a message or post it online.
  - Touch **SET AS** to set the photo as a wallpaper or a contact icon.

Press **MENU**, to edit a photo, view its details.

3. If you want to view more photos, touch the screen, and then touch  or .

### 8.1.4 Shooting a Video

1. Open the camera, and then switch to camcorder mode.
2. If necessary, open the settings panel to change the camcorder settings.
3. Frame the scene which you want to start your video.
4. Touch  to start recording a video. The camcorder starts shooting the video.
5. Touch  to stop shooting. You can shoot another video or preview your videos.

### 8.1.5 Viewing Your Videos

1. After recording a video, a thumbnail of the video you have just recorded is shown in the upper right corner of the Capture screen. Touch the thumbnail to view it.
2. Touch the onscreen button to do any of the following:
  - Touch **DELETE** to delete the video.
  - Touch **SHARE** to send the video in a message or post it online.

- Touch **PLAY** to play the video.

On the video playing screen, touch the controls to skip forward or back or to play or pause the video.

Press **MENU** to view details of the video.

3. If you want to view more videos, touch the screen, and then touch  or .

## 8.2 Using the Gallery

Your **Gallery** application can automatically search for pictures and videos on your mobile phone and microSD card. Use **Gallery** to sort photos and videos into folders, view and edit pictures, watch videos, and set a picture as wallpaper or as a photo for a contact.

### 8.2.1 Opening the Gallery

Touch  > **Gallery** to open the viewer.

The **Gallery** application categorizes your pictures and videos by storage location and stores these files in folders. Touch a folder to view the pictures or videos inside.

Press **MENU** to display the Gallery panel. On the panel, you can do the following:

- Touch **Capture picture** to open the camera and switch to the picture capture mode.
- Touch **Capture video** to open the camera and switch to the video capture mode.
- Touch **Settings** to go to the Gallery settings screen. There, you can set the size of a picture, arrange pictures, play a slideshow, and specify whether to prompt for confirmation when you delete a picture.

### 8.2.2 Viewing a Picture

1. In the **Gallery**, touch the folder that contains the pictures you want to view.
2. Touch the picture to view it in full-screen mode. When viewing a picture in full-screen mode, flick the picture right or left to view the previous or next picture.
3. Touch the screen.

Then the zoom panel appears. You can zoom in or zoom out on the picture.

★ **Tip:** The picture viewer supports the automatic rotation function. When you rotate your mobile phone, the picture adjusts itself to the rotation.

### 8.2.3 Rotating a Picture

1. When viewing a picture, press **MENU** to display the operations panel.
2. Touch **Rotate**.
3. Select either **Rotate left** or **Rotate right**. The picture is saved with the new orientation.

### 8.2.4 Cropping a Picture

1. When viewing a picture, press **MENU** to display the more operations panel, and then touch **Crop**.

2. Use the cropping tool to select the portion of the picture to crop.
  - Drag from the inside of the cropping tool to move it.
  - Drag an edge of the cropping tool to resize the image.
  - Drag a corner of the cropping tool to resize the image without changing the length to width ratio.
3. Touch **Save** to save the cropped picture. Touch **Rotate** to rotate the cropped picture. Touch **Discard** to discard the changes.

## 8.3 Enjoying Music

You can download music files to your PC or insert a CD and copy the files to your microSD card so you can listen to music on your mobile phone.

### 8.3.1 Copying Music to the microSD Card

1. Connect the phone to your computer with a USB cable and mount the microSD card.
2. On the PC, navigate to the USB drive and open it.
3. Create a folder in the root directory of the microSD card (for example, **Music**).
4. Copy the music from your computer to the folder you have created.
5. After copying music, unmount or eject the drive as required by your PC's operating system to safely remove the mobile phone.
6. Disconnect the mobile phone from the PC.

### 8.3.2 Opening the Media Library

Touch  > **Music** to display the media library.

The **Music** application organizes your music files by storage location. It contains four tabs: **Artists**, **Albums**, **Songs** and **Playlists**.

### 8.3.3 Playing Music

1. Touch a category on the music library screen.
2. Touch the song you want to play.

#### ★ Tip:

When you are listening to music, touch , to use another application. Your music continues to play. To return to the music controls, open the notification panel and then touch the song.



## Music Player Screen

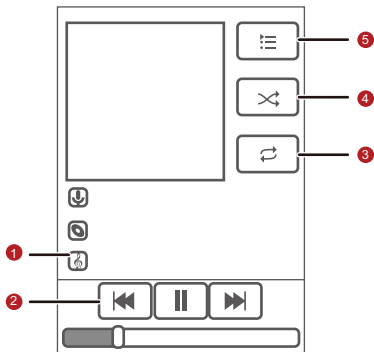

---

1 Touch and hold to search for information.

---

2 Touch to control the music.

---

3 Touch to set the repeat mode.

---

4 Touch to turn the shuffle on or off.

---

5 Touch to open the current playlist.

---

### 8.3.4 Adding Music to a Playlist

1. Touch a category on the music library screen.
2. In the list that appears, use the Navigator key to select the song you want to add to the playlist.
3. Touch and hold the song, and then touch **Add to playlist** in the options menu.
  - Touch **Current playlist** to add the song to an existing playlist.
  - Touch **New** to create a playlist and add the song to it.

### 8.3.5 Playing a Playlist

1. Touch the **Playlists** tab on the music library screen.
2. Touch and hold the playlist you want to play.
3. Touch **Play** to play the playlist.

## 9 Google Services

When you turn on your mobile phone for the first time, touch a Google services such as **Talk**, **Gmail**, or **Market**, and you will be prompted to sign in to your Google account.

■ **Note:**

Ensure that your mobile phone has an active data connection before you sign in to your Google account.

If you already have a Google account, touch **Sign in** and enter your username and password.

### 9.1 Creating a Google Account

If you do not have a Google account, you can create one:

1. After reading the setup information, touch **Next**.
2. Touch **Create**.
3. Enter a first name, last name, and user name for your Google account, and then touch **Next**.  
The mobile phone will connect to the Google server to check whether the username is available. If the username you entered is already in use, you will be prompted to choose another one or select one from a list.
4. Enter and confirm your Google account password.
5. Select a security question from the drop down menu, and then enter the answer.
6. Touch **Create**.
7. When the **Google Terms of Service** screen appears, touch **I agree, Next**.
8. Enter the characters that appear on the screen, and then touch **Next**.

★ **Tip:**

To use another Google account, go to the **Accounts & sync settings** screen, and touch **Add account** to select which type of accounts you want to add.

### 9.2 Using Gmail

**Gmail** is Google's web-based email service. When you first set up your phone, you may have configured it to use an existing **Gmail** account or create a new account. The first time you open the **Gmail** application on your phone, your **Inbox** will contain the messages from your **Gmail** account on the web.

#### 9.2.1 Opening Gmail

Touch  > **Gmail**. The **Inbox** mail list appears. Any emails you decide to keep on your mobile phone will go to your **Inbox** folder.

#### 9.2.2 Switching Between Accounts

1. In the mail list, press **MENU**, and then touch **Accounts**.
2. Touch the account that contains the email you want to read.

### 9.2.3 Creating and Sending an Email

1. In the mail list, press **MENU**, and then touch **Compose**.
2. Enter the message recipient's email address in the **To** field. If you are sending the email to several recipients, separate the email addresses with commas. You can add as many message recipients as you want.  
If you want to send a copy (Cc) or a blind copy (Bcc) of the email to other recipients, press **MENU**, and then touch **Add Cc/Bcc**.
3. Enter the email subject and write your message.  
If you want to add a picture attachment, press **MENU**, and then touch **Attach** to select the picture you want to attach.
4. After composing your email, touch **Send**.

### 9.2.4 Replying To or Forwarding an Email

1. In the mail list, touch the email that you want to reply to or forward, and then scroll down to the end of the email.
2. Touch **Reply**, **Reply to all**, or **Forward**.
3. Do one of the following:
  - If you selected **Reply** or **Reply to all**, enter your message.
  - If you selected **Forward**, specify the message recipients and add any additional text you want to include with the forwarded message.
4. Touch **Send**.

### 9.2.5 Searching for an Email

1. In the mail list, press **MENU**, and then touch **Search**.
2. Enter the search keywords in the box, and then touch .

### 9.2.6 Customizing Your Gmail Settings

1. In the mail list, press **MENU**, and then touch **Settings**.
2. Set the following options:
  - **Signature**: Touch to enter a signature that is appended at the end of all your emails.
  - **Confirm delete**: Select the check box to show a confirmation box when you delete an email.
  - **Batch operations**: Select the check box to show the batch operations feature. This feature lets you archive, delete, or apply a label to multiple emails at the same time.
  - **Clear search history**: Touch to remove the history of previous message searches.
  - **Labels**: Touch to select which **Gmail** labels to synchronized with your web-based **Gmail** account.
  - **Email notifications**: Select the check box to show a notification icon on the notification bar when you receive an email.

- **Select ringtone:** Touch to choose a ringtone for a new email message. A short sample of the ringtone will play when you select it. If you prefer no ringtone to play when you receive a new email message, touch **Silent**. Then touch **OK** to confirm your ringtone selection.
- **Vibrate:** Select the check box if you want your mobile phone to vibrate when you receive a new email message.

## 9.3 Using Talk

**Talk** is Google's instant messaging service. You can use it to communicate in real time with other people using **Talk** on a phone or on the web.

### 9.3.1 Opening Talk

Touch  > **Talk** to open the application.

■ **Note:**

Your Talk account is based on the Google account you set up with your mobile phone.

### 9.3.2 Adding a Friend

1. In the friends list, press **MENU**, and then touch **Add friend**.
2. Enter the **Talk** instant messaging ID or Google email address of the friend you want to add.
3. Touch **Send invitation**.

### 9.3.3 Accepting an Invitation

1. If you have invited anyone to chat or if someone else has invited you to chat, this information will appear in the friends list.
2. Touch a pending invitation, and then touch **Accept** or **Cancel**.

### 9.3.4 Starting a Chat

1. In the friends list, do one of the following:
  - Touch a friend's name in the friends list.
  - Use the Navigation key to select a friend's name, and then press the **Trackball**.
2. Use the onscreen keyboard to enter text and chat with your friend.
3. After entering your message, touch **Send**.

### 9.3.5 Setting Notifications for New Instant Messages

Whenever you receive an instant message, your mobile phone can play a sound, vibrate, or display an icon. To set up one of these handy notifications, start in the friends list, and then press

**MENU**. Then touch **More** > **Settings**. Now choose from one of the following:

---

**IM notifications**

Select the check box to receive a notification on the notification bar when you receive an instant message.

---

---

**Select ringtone**

Touch to choose the ringtone used for a new instant message. You will hear a short sample of the ringtone when you select it. To turn the ringtone off, select **Silent**.

---

**Vibrate**

Select the check box to make your mobile phone vibrate when you receive a new instant message.

---

### 9.3.6 Signing Out of Talk

In the friends list screen, press **MENU**, and then touch **More > Sign out** to quit **Talk**.

## 9.4 Using Maps

**Maps** lets you find your current location, view real-time traffic conditions (depending on availability in your locale), and get detailed directions to various destinations on a satellite, traffic, or other kind of map.

### 9.4.1 Enabling Location Source

Before you open **Maps** to find your location or search for places of interest, you must enable "location source".

1. Touch  > **Settings**.
2. Touch **Location & security**.
3. In the **My Location** section, select the **Use wireless networks** check box, **Use GPS satellites** check box, or both.

### 9.4.2 Opening Maps

Touch  > **Maps** to open the application.

### 9.4.3 Searching for Places of Interest

1. On the map, press **MENU**, and then touch **Search**.
2. Enter the place you want to search for in the search box, and then touch the Search icon.
3. Your search results will then be displayed. Touch a place you are interested in and the application will show where it is on the map.

### 9.4.4 Getting Directions

1. While viewing a map, press **MENU**, and then touch **Directions**.
2. Enter the starting point in the first text box, and then enter your destination in the second text box.
3. Touch the icon for car, public transit, or walking directions.
4. Touch **Go**. Your directions will appear in a list.

5. Touch a direction item on the list to show it on the map.
6. When you finish viewing or following the directions, press **MENU** and touch **More > Clear Map** to reset the map.

## 9.5 Using Market

Android Market provides direct access to applications and games which you can download and install on your phone.

When downloading paid applications from Android Market, you need to log in to the Google Checkout account and use your credit card to buy the applications.

### 9.5.1 Opening Market

1. Touch  > **Market**.
2. When you open **Market** for the first time, the **Android Market Terms of Service** window will appear. Touch **Accept** to continue.

### 9.5.2 Searching for Applications

There are a few different ways to find applications on the **Market** home screen, including:

- Featured applications: Scroll horizontally to view more.
- List of applications by category: Includes subcategories, which you can sort by popularity (most to least) or by date (newest to oldest).
- List of games.
- Search function.
- Your downloads.

### 9.5.3 Installing an Application

#### ■ Note:

If you want to install a non-Market application, touch  > **Settings > Applications**, and then select the **Unknown sources** check box to allow installation of the non-Market application.

1. In the **Market**, touch **Apps**.
2. Touch a category, and then touch the item you want to download.
3. On the item details screen, read more about the application, including its cost, overall rating, and user comments. If you scroll down to the **About the developer** section, you can see other applications from the same developer, link to the developer's website, or send the developer an email.
4. To install the item, touch **Install** (if the item is free) or **Buy**, whichever is displayed.
5. To check the progress of a download, open the notification panel. Most applications are installed within seconds. To stop an item from downloading, touch **Cancel download**.
6. After the application has been downloaded and installed on your mobile phone, the content download icon appears in the notification bar.

## 9.5.4 Uninstalling an Application

1. On the **Market** screen, touch **Downloads**.
2. Touch the application you want to uninstall, and then touch **Uninstall**.
3. When prompted, touch **OK** to remove the application from your mobile phone.
4. Choose the reason for removing the application, and then touch **OK**.

## 10 Synchronizing Information

Some applications on your mobile phone give you access to the same personal information that you can add, view, and edit on your computer. If you add, change, or delete your information in any of these applications on the web, the updated information also appears on your mobile phone.

This is made possible through over-the-air data synchronization. The process occurs in the background and does not interfere with use of your mobile phone. When your phone is synchronizing, a data synchronization icon will be shown in the notification bar.

### 10.1 Managing Your Accounts

You can synchronize contacts, email, and other information on your mobile phone with multiple Google accounts or other kinds of accounts, depending on the applications installed on your mobile phone.

For example, you can start by adding your personal Google account, so your personal email, contacts, and calendar are always available. You could then add a work account, so your work-related emails work contacts are handy. If you like, you may add multiple Google accounts or other accounts.

#### 10.1.1 Adding an Account

When you add an account, **Contacts** compares contacts from the newly synchronized account with contacts from your existing mobile phone accounts and attempts to merge duplicates into a single entry in **Contacts**. While it is presented as a single contact entry, the contact data itself is not merged.

1. Touch  > **Settings** > **Accounts & sync**. The screen displays your current synchronization settings and a list of your current accounts.
  - **Note:** In some cases, you may need to obtain account details from an IT support. For example, you may need to know the account's domain or server address.
2. Touch **Add account**.
3. Touch the kind of account to add.
4. Follow the onscreen steps to enter the required and optional information about the account. Most accounts require a username and password, but the details depend on the kind of account and the configuration of the service to which you are connecting.
5. Configure the account. Depending on the kind of account, you may be asked to configure what kind of data you want to sync to the mobile phone, to name the account, and for other details. When you are finished, the account is added to the list in the **Accounts & sync settings** screen.

#### 10.1.2 Removing an Account

You can remove an account, deleting it and all information associated with it from your mobile phone, including email, contacts, settings, and so on. You cannot, however, remove some accounts, such as the first account you signed into on the mobile phone. If you attempt to remove certain accounts, all personal information associated with it will be deleted.

1. On the **Accounts & sync settings** screen, touch the account to delete.



2. Touch **Remove account**.
3. Confirm that you want to remove the account.

## 10.2 Customizing Your Account Synchronization

You can configure background data use and synchronization options for all the applications on your phone. You can also configure what kind of data you synchronize for each account.

Some applications, such as **Contacts** and **Gmail**, can synchronize data from multiple applications. Others, such as **Calendar**, synchronize data only from the first Google account you signed into on your phone, or from an account associated specifically with that application.

For some accounts, synchronizing is two-directional; changes that you make to the information on your mobile phone are made to the copy of that information on the web. Some accounts support only one-way synchronize; the information on your mobile phone is read-only.

### 10.2.1 Configuring General Sync Settings

On the **Accounts & sync settings** screen, do the following:

- Select or clear the **Background data** check box to control whether applications and services can transmit data when you are not working with them directly (that is, when they are running in the background).

If you clear this option, **Gmail** stops receiving new mail, **Calendar** stops synchronizing events, and so on, until you touch the **Refresh** menu item or send an email.

- Select or clear the **Auto-sync** check box to control whether changes you make to information on the phone or on the web are automatically synchronized with each other.

For example, when this option is selected, changes that you make in **Contacts** on the phone are automatically made in Google Contacts on the web.

### 10.2.2 Changing an Account's Synchronization Settings

1. On the **Accounts & sync settings** screen, touch the account whose synchronization settings you want to change. The data and synchronization screen opens, displaying a list of the kinds of information the account can synchronize.
2. Selected items are configured to synchronize to your mobile phone.
3. Select or clear the check box of information you want to synchronize to the mobile phone.

# 11 Using Other Applications

## 11.1 Using the Calendar

Use **Calendar** to create and manage events, meetings, and appointments. Depending on your synchronization settings, the calendar on your phone stays in synchronization with your calendar on the web.

### 11.1.1 Opening the Calendar

Touch  > **Calendar** to open the application.

★ **Tip:**

To access Google calendar, press **MENU**, and then touch **More > Launch Google Calendar**. The Google calendar service can be synchronized with the Google server, whereas the calendar application on your mobile phone cannot.

### 11.1.2 Creating an Event

1. On any calendar view, press **MENU**. Then touch **New event** to open the **Event details** screen.
2. Enter the event name on the keyboard.
  - If there is a time frame for the event, touch **From** and **To**, so you can set the duration of the event.
  - If it is a special occasion such as a birthday or a day-long event, set dates for **From** and **To**, and then select the **All day** check box.
3. Enter the location of the event and the description.
4. If you have more than one calendar, select the calendar where you want to save the event.
5. Enter email addresses to invite guests to the event.
6. Set the time of your event reminder in **Reminders**, and then specify in **Repetition** whether the event recurs and its frequency of recurrence.
7. Touch **Save**.

★ **Tip:**

To quickly create an event in the **Day**, **Week**, or **Month** view, touch and hold an empty time slot, and then touch **New event**. A new event details screen will appear with the selected time slot and date in the **From** and **To** fields.

### 11.1.3 Setting an Event Reminder

1. On any calendar view, touch an event to view its details or event summary.
2. Touch the **Add reminder** button to add a reminder. Or touch the reminder's "-" button to delete it.
3. Touch the reminder time, and then touch the length of time before the event when you want to be reminded. When the time comes, you will receive a notification about the event.

### 11.1.4 Customizing the Calendar Settings

On any calendar view, press **MENU**. Then touch **More > Settings**.

- **Hide declined events:** Select to hide events for which you have declined invitations.
- **Set alerts & notifications:** Touch to set event reminders to alert you, send you a notification, or turn off event notifications on your mobile phone.
- **Select ringtone:** Touch to select the ringtone to sound when you receive an event reminder.
- **Vibrate:** Select to vibrate the mobile phone when you receive an event notification.
- **Default reminder time:** Touch to select the default time before an event for event reminders to occur.

## 11.2 Using the Alarm

You can set a new alarm or modify an existing alarm.

### 11.2.1 Opening the Alarm

Touch  > **Alarm** to use your mobile phone alarm.

### 11.2.2 Adding an Alarm

1. On the alarm list screen, press **MENU**, and then touch **Add alarm**.
2. Set the alarm, and then touch **Done**.

### 11.2.3 Setting an Alarm

1. On the alarm list screen, touch one of the alarms on the screen.
2. Touch **Time** to set the time of the alarm.
3. Touch **Ringtone** to select a ringtone for the alarm.
4. Select the **Vibrate** check box to have the phone vibrate, in addition to playing the ringtone.
5. Touch **Repeat** to set the days when you want the alarm to sound.
6. Touch **Label** to enter a name for the alarm.
7. Touch **Done**.

### 11.2.4 Customizing Alarm Settings



On the alarm list screen, press **MENU**, and then touch **Settings**.

- **Alarm in silent mode:** Select to sound alarms even when the phone is in silent mode.
- **Alarm volume:** Touch to open a dialog where you can set the volume of all alarms.
- **Snooze duration:** Touch to open a dialog where you can set how long the alarm waits before it sounds again.
- **Side button behavior:** Touch to open a dialog where you can set what happens if you press the side buttons when an alarm sounds.

## 11.3 Using Sound Recorder

**Sound Recorder** is useful for quickly recording thoughts. You can also record your voice and set it as a ringtone.

### 11.3.1 Starting a Recording

1. Touch  > **Sound Recorder** to open the application.
2. Touch  to start recording.
3. Record your desired message.
4. Touch  to stop recording.
5. Press **MENU**, and then touch **Recordings** to view the voice clip.

### 11.3.2 Setting a Voice Clip as a Ringtone

1. On the sound recorder screen, press **MENU**, and then touch **Recordings**.
2. Select the location where you have saved the recordings.
3. Select a voice clip, and then press **MENU**.
4. Touch **Set as ringtone**.

## 11.4 Using the File Manager

**File Manager** is like having a pocket-sized personal assistant (PA), letting you organize, edit, and delete files and folders.

### 11.4.1 Opening the File Manager

Touch  > **File Manager** to open the application.

### 11.4.2 Creating a Folder

1. On the **File Manager** screen, access the directory of the folder you want to create.
2. Press **MENU** to open the options panel, and then touch **New folder**.
3. Enter the name of the new folder in the text box.
4. Touch **Save**.

### 11.4.3 Moving or Copying a File

1. On the **File Manager** screen, press **MENU** to show the options panel, and then touch **Cut** or **Copy**.
2. Touch the file or folder you want to move or copy. When selected, a check mark will appear.

To select all files, press **MENU** to open the options panel. Then touch **Select all** to select all files in a folder (touch **Unselect all** to cancel the selection).

3. Press **MENU** to open the options panel, and then touch **Done** to cut or copy the file.
4. Now select the path to where you want the file to be copied or moved. Press **MENU** to open the options panel, and then touch **Paste** to move or copy the file to the selected path.

#### 11.4.4 Doing a Quick Search for a File

1. On the **File Manager** screen, touch a folder to access the directory where the file you want is located.
2. Press **MENU** to open the options panel, and then touch **Search**.
3. Write a key word of the name of your file or folder in the search box.
4. Touch **Search**. Your mobile phone will start the search.
5. A list of search results will be displayed. Touch a file in the list to open it.
6. Touch **New search** for a new search or press the Back key to return to the file manager screen.

#### 11.4.5 Viewing Your Memory Status

On the **File Manager** screen, press **MENU** to open the options panel, and then touch **Memory Status**. The memory management screen will be displayed. This screen allows you to view the memory status and available memory on your mobile phone and microSD card.

### 11.5 Using the Calculator

Use the calculator to solve simple arithmetic problems or use its advanced operators to solve more complex equations.

#### 11.5.1 Opening the Calculator

Touch  > **Calculator** to open the application.

#### 11.5.2 Switching to the Advanced panel

On the **Calculator** screen, flick the screen to the right or left to switch between **Advanced panel** and **Basic panel**.

### 11.6 Using the Notepad

**Notepad** features a simple text processor and lists all notes in a linear structure. You can add, edit, and delete notes.

1. Touch  > **Notepad** to open the application.
2. Press **MENU**, and then touch **Add note** to create a note.
3. After editing, press **MENU**, and then touch **Save**.

# 12 Managing Your Mobile Phone

To configure your mobile phone, touch  > **Settings**.

## 12.1 Setting the Date and Time

By default, your mobile phone automatically uses the date, time zone, and time provided by the network.

■ **Note:**

When the time provided by the network is automatically used, you cannot set the date, time, and time zone. In this case, you can touch **Settings** > **Date & time** to set only date and time formats.

## 12.2 Setting the Display

### 12.2.1 Adjusting the Screen Brightness

1. On the **Settings** screen, touch **Sound & display** > **Brightness**.
2. Drag the slider left to make the screen darker, or right to make it brighter.
3. Touch **OK** to save the adjustment.

### 12.2.2 Adjusting the Time Before the Screen Turns Off

If your mobile phone is idle for a while, it will turn off the screen to save battery power. To set a longer or shorter idle time, do the following:

1. On the **Settings** screen, touch **Sound & display** > **Screen timeout**.
2. Select the duration you want the screen to be illuminated.

## 12.3 Setting Ringers

### 12.3.1 Turning On Silent Mode

1. On the **Settings** screen, touch **Sound & display**.
2. Select the **Silent mode** check box. Then all sounds except media and alarms are silenced.

### 12.3.2 Adjusting the Ringer Volume

You can adjust the ringer volume when you are on the Home screen or any application screens (except during a call or when playing music or videos). Press the Volume keys to adjust the ringer volume to your desired level.

You can also adjust the ringer volume on the settings screen.

1. On the **Settings** screen, touch **Sound & display** > **Ringer volume**.
2. Drag the slider left to make the volume softer, or right to make it louder.
3. Touch **OK** to save the adjustment.

On the **Ringer volume** screen, if you do not select **Use incoming call volume for notifications**, you can set **Incoming call volume** and **Notification volume** separately.

### 12.3.3 Adjusting the Media Volume

When playing music or watching videos, press the Volume keys to adjust the sound.

You can also adjust the sound on the settings screen.

1. On the **Settings** screen, touch **Sound & display > Media volume**.
2. Drag the slider left to make the volume softer, or right to make it louder.
3. Touch **OK** to save the adjustment.

### 12.3.4 Changing the Phone Ringtone

1. On the **Settings** screen, touch **Sound & display > Phone ringtone**.
2. Touch the ringtone you want to use, and then touch **OK**. The ringtone plays when selected.

#### ★ Tip:

You can set a song as the ringtone. Open the Music application, and then press and hold the song name, and select **Use as phone ringtone**.

### 12.3.5 Setting Your Phone to Vibrate for Incoming Calls

1. On the **Settings** screen, touch **Sound & display**.
2. Select the **Phone vibrate** check box. Then mobile phone will vibrate when there is an incoming call.

## 12.4 Setting Phone Services

### 12.4.1 Customizing Call Settings

Your mobile phone service provider offers different services such as voicemail. You can customize many of these services if they are part of your calling plan.

On the **Settings** screen, touch **Call settings** to customize your call functions.

### 12.4.2 Turning on Data Roaming

1. On the **Settings** screen, touch **Wireless & networks > Mobile networks**.
2. Select the **Data roaming** check box.

#### ■ Note:

Accessing data services while roaming may incur additional charges. Ask your wireless service provider about data roaming fees.

### 12.4.3 Switching off the Data Service

1. On the **Settings** screen, touch **Wireless & networks > Mobile networks**.
2. Clear the **Data Service** check box.

### 12.4.4 Switching on Always-on Mobile Data

If you have not selected **Enable always-on mobile data**, after your screen is locked for 30 minutes, your mobile phone will automatically stop all data services. For example, your mobile phone will not check new emails or synchronize data in the background. The mobile phone will automatically enable data services only after you have waken up your screen.

On the **Settings** screen, touch **Wireless & networks > Mobile networks**. Select **Enable always-on mobile data** to enable this function.

## 12.5 Protecting Your Mobile Phone

### 12.5.1 Protecting Your Mobile Phone with a Screen Lock

To keep your data more secure, lock the screen and/or require a screen unlock pattern every time your mobile phone is turned on or wakes up from sleep mode.

1. On the **Settings** screen, touch **Location & security > Set unlock pattern**.
2. Connect at least four dots in a vertical, horizontal and/or diagonal direction, and then lift your finger from the screen when complete.  
You must flick your finger on the screen to create the pattern and not touch individual dots.
3. Your mobile phone will record the pattern. Touch **Continue**.
4. When prompted, draw the screen unlock pattern again, and then touch **Confirm**.

Clear the **Use visible pattern** check box if you do not want the unlock pattern to be displayed on the screen when you unlock it.

To change your unlock screen pattern, touch **Location & security > Change unlock pattern**.

## 12.6 Managing Applications

### 12.6.1 Viewing an Installed Application

1. On the **Settings** screen, touch **Applications > Manage applications**.
2. In the applications list, do any of the following:
  - Press **MENU**, and then touch **Sort by size**. Then touch an application to view its details.
  - Press **MENU**, and then touch **Filter**. Select **All**, **Running**, or **Downloaded** from the options menu. Then touch an application to view its details.
  - Touch an application to view its details directly.

### 12.6.2 Removing an Installed Application

1. On the **Settings** screen, touch **Applications > Manage applications**.
2. Touch an application, and then touch **Uninstall** to remove the application from your mobile phone.

### 12.6.3 Ways to Free Up Your Mobile Phone Memory

- Move files and email attachments to the microSD card.
- In **MetroWEB**, clear all temporary Internet files and the MetroWEB history information.
- Uninstall the downloaded programs that you no longer use.
- Reset your mobile phone.



## 12.7 Resetting Your Mobile Phone

### 12.7.1 Backing Up My Settings

You can back up your mobile phone's settings to Google servers, with your Google account. If you replace your mobile phone, the settings you have backed up are stored on the new mobile phone the first time you sign in with your Google account.

1. On the **Settings** screen, touch **Privacy**.
2. Select the **Back up my settings** check box.

### 12.7.2 Restoring Factory Data

If you reset your phone to the settings that were configured at the factory, all of your personal data from internal phone storage, including information about your Google Account, any other accounts, your system and application settings, and any downloaded applications will be erased. Resetting the phone does not erase any system software updates you've downloaded or any files on your microSD card, such as music or photos.

1. On the **Settings** screen, touch **Privacy > Factory data reset**.
2. When prompted, touch **Reset phone**, and then touch **Erase everything**. The mobile phone resets the settings to the original factory settings, and then restarts.

## 12.8 Manually Upgrading the Software Version

Before upgrading the software on your mobile phone, ensure that your mobile phone is fully charged and the upgrade version is correct. Back up important information such as the contacts, email messages, files, and other messages saved on your mobile phone.

### 12.8.1 Downloading the Upgrade Package

You can download the software upgrade files from the following websites:

- <http://www.huaweidevice.com/worldwide/technicalIndex.do>

### 12.8.2 Preparing for the Upgrade

1. Download the upgrade file from the appropriate websites.
2. The file you download will be compressed. Use the unzip software on your PC to decompress the upgrade package. The upgrade package has a folder structure – be careful you do not change it. This folder is called **dload** – do not rename it, either.
3. Use the USB cable to connect your mobile phone to your PC.
4. Copy the folder structure to the main directory (root directory) of your microSD card.
5. After you have copied the file to the microSD card, disable the USB mass storage feature.

### 12.8.3 Upgrading the Software through the microSD Card

After copying the update files to the microSD card, do the following:

1. On the **Settings** screen, touch **SD card & phone storage > Software Upgrade > Upgrade Via SD card**.

2. Before the upgrade, the system of your mobile phone automatically checks the battery level and the upgrade version. If the version you have downloaded does not meet the upgrade requirements, the upgrade will not work.
3. When the next message appears, touch **Confirm**.
4. Touch **Upgrade**.
5. Your mobile phone restarts and the upgrade screen is displayed.
6. After the upgrade is complete, your mobile phone automatically restarts and will switch on again.
7. Touch **About phone** > **Build number** to view the version information.

## 12.9 Upgrading the Software Version Through FOTA

Your mobile phone supports Firmware Over the Air (FOTA) function. This function helps you upgrade the software of your phone automatically. This function is based on Device Management (DM) function and includes two process, the download processes and the update process.

### ■ Note:

- Back up important information such as the contacts, email messages, files, and other messages saved to your mobile phone before the update process starts.
- Make sure your battery is fully charged or your phone connected to the charger during the update process.
- Do not interrupt the update process.
- Your phone will restart no matter whether or not the update process succeeds or fails.
- Visit the closest MetroPCS store for technical assistance if the update process fails.

### 12.9.1 Download process of FOTA

Your mobile phone downloads the upgrade package automatically in this process.

An icon  and message "Important enhancement download in progress" will be displayed on the notification bar during the FOTA download session.

■ **Note:** Note that the upgrade package cannot be downloaded if Wi-Fi connection is active.

### 12.9.2 Update process of FOTA

Your mobile phone updates the software automatically in this process.

You will be shown 30 seconds countdown in Notification Bar.

This Notification is refreshed after every 5 seconds, till it reaches zero. The device shall start the firmware update automatically when the countdown reaches zero.

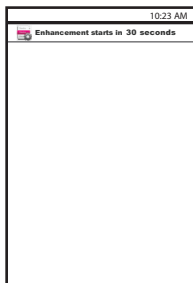

You can select the notification by dragging down the notification bar and click on the firmware update notification before the countdown reaches zero seconds.

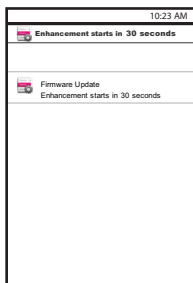

On click on notification, you will be prompted an update confirmation message as shown below.

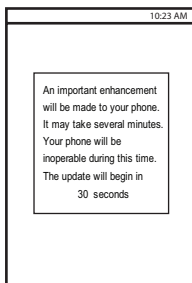

- **Note:** A Count Down of 30 seconds will be shown in the Notification. You can cancel the update process by selecting the Firmware Update notification and press  in the update confirmation screen within thirty seconds, and you will be prompted again after five minutes. If the battery is low, the update process cannot be started and you will be prompted the following message.

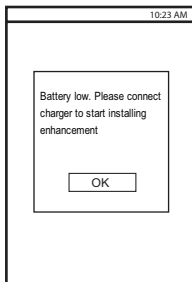

# 13 Appendix

## 13.1 Warnings and Precautions

This section contains important information pertaining to the operating instructions of your device. It also contains information about how to use the device safely. Read this information carefully before using your device.

### **Electronic Device**

Power off your device if using the device is prohibited. Do not use the device when using the device causes danger or interference with electronic devices.

### **Medical Device**

- Follow rules and regulations set forth by hospitals and health care facilities. Do not use your device when using the device is prohibited.
- Pacemaker manufacturers recommend that a minimum distance of 15 cm be maintained between a device and a pacemaker to prevent potential interference with the pacemaker. If you are using a pacemaker, use the device on the opposite side of the pacemaker and do not carry the device in your front pocket.
- Some wireless devices may affect the performance of hearing aids. For any such problems, consult your service provider.
- To ensure that the Hearing Aid Compatibility rating for your device is maintained, secondary transmitters such as Bluetooth and Wi-Fi components must be disabled during a call.

### **Potentially Explosive Atmosphere**

Power off your device in any area with a potentially explosive atmosphere, and comply with all signs and instructions. Areas that may have potentially explosive atmospheres include the areas where you would normally be advised to turn off your vehicle engine. Triggering of sparks in such areas could cause an explosion or a fire, resulting in bodily injuries or even deaths. Do not power on your device at refueling points such as service stations. Comply with restrictions on the use of radio equipment in fuel depots, storage, and distribution areas, and chemical plants. In addition, adhere to restrictions in areas where blasting operations are in progress. Before using the device, watch out for areas that have potentially explosive atmospheres that are often, but not always, clearly marked. Such locations include areas below the deck on boats, chemical transfer or storage facilities, and areas where the air contains chemicals or particles such as grain, dust, or metal powders. Ask the manufacturers of vehicles using liquefied petroleum gas (such as propane or butane) whether this device can be safely used in their vicinity.

### **Traffic Security**

Observe local laws and regulations while using the device. In addition, if using the device while driving a vehicle, comply with the following guidelines:

- Concentrate on driving. Your first responsibility is to drive safely.
- Do not talk on the device while driving. Use hands-free accessories.
- When you have to make or answer a call, park the vehicle at the road side before using your device.

- RF signals may affect electronic systems of motor vehicles. For more information, consult the vehicle manufacturer.
- In a motor vehicle, do not place the device over the air bag or in the air bag deployment area. Otherwise, the device may hurt you owing to the strong force when the air bag inflates.
- Do not use your device while flying in an aircraft. Power off your device before boarding an aircraft. Using wireless devices in an aircraft may cause danger to the operation of the aircraft and disrupt the wireless telephone network. It may also be considered illegal.

### **Operating Environment**

- Do not use or charge the device in dusty, damp, and dirty places or places with magnetic fields. Otherwise, it may result in a malfunction of the circuit.
- The device complies with the RF specifications when the device is used near your ear or at a distance of 1.5 cm from your body. Ensure that the device accessories such as a device case and a device holster are not composed of metal components. Keep your device 1.5 cm away from your body to meet the requirement earlier mentioned.
- On a stormy day with thunder, do not use your device when it is being charged, to prevent any danger caused by lightning.
- When you are on a call, do not touch the antenna. Touching the antenna affects the call quality and results in increase in power consumption. As a result, the talk time and the standby time are reduced.
- While using the device, observe the local laws and regulations, and respect others' privacy and legal rights.
- Keep the ambient temperature between 0°C and 45°C while the device is being charged. Keep the ambient temperature between -10°C to 55°C for using the device powered by a battery.

### **Prevention of Hearing Damage**

Using a headset at high volume can damage your hearing. To reduce the risk of damage to hearing, lower the headset volume to a safe and comfortable level.

### **Safety of Children**

Comply with all precautions with regard to children's safety. Letting the child play with your device or its accessories, which may include parts that can be detached from the device, may be dangerous, as it may present a choking hazard. Ensure that small children are kept away from the device and accessories.

### **Accessories**

Use the accessories delivered only by the manufacturer. Using accessories of other manufacturers or vendors with this device model may invalidate any approval or warranty applicable to the device, result in the non-operation of the device, and cause danger.

### **Battery and Charger**

- Unplug the charger from the electrical plug and the device when not in use.
- The battery can be charged and discharged hundreds of times before it eventually wears out. When the standby time and the talk time are shorter than the normal time, replace the battery.
- Use the AC power supply defined in the specifications of the charger. An improper power voltage may cause a fire or a malfunction of the charger.

- Do not connect two poles of the battery with conductors, such as metal materials, keys, or jewelries. Otherwise, the battery may be short-circuited and may cause injuries and burns on your body.
- If battery electrolyte leaks out, ensure that the electrolyte does not touch your skin and eyes. When the electrolyte touches your skin or splashes into your eyes, wash your eyes with clean water immediately and consult a doctor.
- If there is a case of battery deformation, color change, or abnormal heating while you charge or store the battery, remove the battery immediately and stop using it. Otherwise, it may lead to battery leakage, overheating, explosion, or fire.
- If the power cable is damaged (for example, the cord is exposed or broken), or the plug loosens, stop using the cable at once. Otherwise, it may lead to an electric shock, a short circuit of the charger, or a fire.
- Do not dispose of batteries in fire as they may explode. Batteries may also explode if damaged.
- Do not modify or remanufacture, attempt to insert foreign objects into the battery, immerse or expose to water or other liquids, expose to fire, explosion or other hazard.
- Avoid dropping the device or battery. If the device or battery is dropped, especially on a hard surface, and the user suspects damage, take it to a qualified service center for inspection.
- Improper battery use may result in a fire, explosion or other hazard.
- Promptly dispose of used batteries in accordance with local regulations.
- The device should only be connected to products that bear the USB-IF logo or have completed the USB-IF compliance program.
- Only use the battery with a charging system that has been qualified with the system per this standard, IEEE-Std-1725-2006. Use of an unqualified battery or charger may present a risk of fire, explosion, leakage, or other hazard.
- Replace the battery only with another battery that has been qualified with the system per this standard, IEEE-Std-1725-2006. Use of an unqualified battery may present a risk of fire, explosion, leakage or other hazard.

## **Cleaning and Maintenance**

- The device, battery, and charger are not water-resistant. Keep them dry. Protect the device, battery, and charger from water or vapor. Do not touch the device or the charger with a wet hand. Otherwise, it may lead to a short circuit, a malfunction of the device, and an electric shock to the user.
- Do not place your device, battery, and charger in places where they can get damaged because of collision. Otherwise, it may lead to battery leakage, device malfunction, overheating, fire, or explosion.
- Do not place magnetic storage media such as magnetic cards and floppy disks near the device. Radiation from the device may erase the information stored on them.
- Do not leave your device, battery, and charger in a place with an extreme high or low temperature. Otherwise, they may not function properly and may lead to a fire or an explosion. When the temperature is lower than 0°C, performance of the battery is affected.
- Do not place sharp metal objects such as pins near the earpiece. The earpiece may attract these objects and hurt you when you are using the device.
- Before you clean or maintain the device, power off the device and disconnect it from the charger.

- Do not use any chemical detergent, powder, or other chemical agents (such as alcohol and benzene) to clean the device and the charger. Otherwise, parts of the device may be damaged or a fire can be caused. You can clean the device and the charger with a piece of damp and soft antistatic cloth.
- Do not dismantle the device or accessories. Otherwise, the warranty on the device and accessories is invalid and the manufacturer is not liable to pay for the damage.
- If the device screen is broken by colliding with hard objects, do not touch or try to remove the broken part. In this case, stop using the device immediately, and then contact an authorized service center in time.

## **Emergency Call**

You can use your device for emergency calls in the service area. The connection, however, cannot be guaranteed in all conditions. You should not rely solely on the device for essential communications.

## **Certification Information (SAR)**

This device meets guidelines for exposure to radio waves.

Your device is a low-power radio transmitter and receiver. As recommended by international guidelines, the device is designed not to exceed the limits for exposure to radio waves. These guidelines were developed by the independent scientific organization International Commission on Non-Ionizing Radiation Protection (ICNIRP) and include safety measures designed to ensure safety for all users, regardless of age and health.

The Specific Absorption Rate (SAR) is the unit of measurement for the amount of radio frequency energy absorbed by the body when using a device. The SAR value is determined at the highest certified power level in laboratory conditions, but the actual SAR level of the device when being operated can be well below the value. This is because the device is designed to use the minimum power required to reach the network.

The SAR limit adopted by USA and Canada is 1.6 watts/kilogram (W/kg) averaged over one gram of tissue. The highest SAR value reported to the FCC and IC for this device type when tested for use at the ear is 1.19 W/kg, and when properly worn on the body is 1.22 W/kg.

## **FCC Statement**

This equipment has been tested and found to comply with the limits for a Class B digital device, pursuant to Part 15 of the FCC Rules. These limits are designed to provide reasonable protection against harmful interference in a residential installation. This equipment generates, uses and can radiate radio frequency energy and, if not installed and used in accordance with the instructions, may cause harmful interference to radio communications. However, there is no guarantee that interference will not occur in a particular installation. If this equipment does cause harmful interference to radio or television reception, which can be determined by turning the equipment off and on, the user is encouraged to try to correct the interference by one or more of the following measures:

--Reorient or relocate the receiving antenna.

--Increase the separation between the equipment and receiver.

--Connect the equipment into an outlet on a circuit different from that to which the receiver is connected.



--Consult the dealer or an experienced radio/TV technician for help.

This device complies with Part 15 of the FCC Rules. Operation is subject to the following two conditions: (1) this device may not cause harmful interference, and (2) this device must accept any interference received, including interference that may cause undesired operation.

 **Caution**

Changes or modifications made to this device not expressly approved by Huawei Technologies Co., Ltd. may void the FCC authorization to operate this device.

**Hearing Aid Compatibility (HAC) regulations for Mobile phones**

In 2003, the FCC adopted rules to make digital wireless telephones compatible with hearing aids and cochlear implants. Although analog wireless phones do not usually cause interference with hearing aids or cochlear implants, digital wireless phones sometimes do because of electromagnetic energy emitted by the phone's antenna, backlight, or other components.

Your phone is compliant with FCC HAC regulations (ANSI C63.19).

While some wireless phones are used near some hearing devices (hearing aids and cochlear implants), users may detect a buzzing, humming, or whining noise.

Some hearing devices are more immune than others to this interference noise, and phones also vary in the amount of interference they generate.

The wireless telephone industry has developed a rating system for wireless phones, to assist hearing device users find phones that may be compatible with their hearing devices. Not all phones have been rated. Phones that are rated have the rating on their box or a label located on the box. The ratings are not guarantees. Results will vary depending on the user's hearing device and hearing loss. If your hearing device happens to be vulnerable to interference, you may not be able to use a rated phone successfully. Trying out the phone with your hearing device is the best way to evaluate it for your personal needs.

M-Ratings: Phones rated M3 or M4 meet FCC requirements and are likely to generate less interference to hearing devices than phones that are not labeled.

M4 is the better/higher of the two ratings.

T-Ratings: Phones rated T3 or T4 meet FCC requirements and are likely to be more usable with a hearing device's telecoil ("T Switch" or "Telephone Switch") than unrated phones. T4 is the better/higher of the two ratings. (Note that not all hearing devices have telecoils in them.) Hearing devices may also be measured.

Your phone meets the M4/T4 level rating. Hearing devices may also be rated. Your hearing device manufacturer or hearing health professional may help you find this rating.

For more information about the FCC Hearing Aid Compatibility please go to <http://www.fcc.gov/cgb/dro>.